

Cambridge Working Paper Economics

Cambridge Working Paper Economics: 1722

A SOCIAL COST BENEFIT ANALYSIS OF GRID-SCALE ELECTRICAL ENERGY STORAGE PROJECTS: EVALUATING THE SMARTER NETWORK STORAGE PROJECT

Arjan S. Sidhu, Michael G. Pollitt, and Karim L. Anaya

23 May 2017

This study explores and quantifies the social costs and benefits of grid-scale electrical energy storage (EES) projects in Great Britain. The case study for this report is the Smarter Network Storage project, a 6 MW/10MWh lithium battery placed at the Leighton Buzzard Primary substation to meet growing local peak demand requirements. This study analyses both the locational and system-wide benefits to grid-scale EES, determines the realistic combination of those social benefits, and juxtaposes them against the social costs across the lifecycle of the battery to determine the techno-economic performance. Risk and uncertainty from the benefit streams, cost elements, battery lifespan, and discount rate are incorporated into a Monte Carlo simulation. Using this framework, society can be guided to cost-effectively invest in EES as a grid modernization asset to facilitate the transition to a reliable, affordable, and clean power system.

A Social Cost Benefit Analysis of Grid-Scale Electrical Energy Storage Projects: *Evaluating the Smarter Network Storage Project*

EPRG Working Paper 1710

Cambridge Working Paper in Economics 1722

**Arjan S. Sidhu, Michael G. Pollitt, and Karim L.
Anaya**

Abstract This study explores and quantifies the social costs and benefits of grid-scale electrical energy storage (EES) projects in Great Britain. The case study for this report is the Smarter Network Storage project, a 6 MW/10MWh lithium battery placed at the Leighton Buzzard Primary substation to meet growing local peak demand requirements. This study analyses both the locational and system-wide benefits to grid-scale EES, determines the realistic combination of those social benefits, and juxtaposes them against the social costs across the lifecycle of the battery to determine the techno-economic performance. Risk and uncertainty from the benefit streams, cost elements, battery lifespan, and discount rate are incorporated into a Monte Carlo simulation. Using this framework, society can be guided to cost-effectively invest in EES as a grid modernization asset to facilitate the transition to a reliable, affordable, and clean power system.

Keywords electrical energy storage, battery, social cost benefit analysis

JEL Classification L94, L98, Q48, D61

Contact
Publication
Financial Support

asidhu4@jhu.edu
June 2017

A Social Cost Benefit Analysis of Grid-Scale Electrical Energy Storage Projects: *Evaluating the Smarter Network Storage Project*

*Arjan S. Sidhu
Michael G. Pollitt
Karim L. Anaya*

*Energy Policy Research Group
University of Cambridge*

23 May 2017

Abstract

This study explores and quantifies the social costs and benefits of grid-scale electrical energy storage (EES) projects in Great Britain. The case study for this report is the Smarter Network Storage project, a 6 MW/10MWh lithium battery placed at the Leighton Buzzard Primary substation to meet growing local peak demand requirements. This study analyses both the locational and system-wide benefits to grid-scale EES, determines the realistic combination of those social benefits, and juxtaposes them against the social costs across the lifecycle of the battery to determine the techno-economic performance. Risk and uncertainty from the benefit streams, cost elements, battery lifespan, and discount rate are incorporated into a Monte Carlo simulation. Using this framework, society can be guided to cost-effectively invest in EES as a grid modernization asset to facilitate the transition to a reliable, affordable, and clean power system.

Keywords: electrical energy storage, battery, social cost benefit analysis

JEL classification: L94, L98, Q48, D61

1. Introduction

The electricity grid is critical to supplying reliable, affordable, and increasingly clean power to support socio-economic development and quality of life. In many applications around the world, electrical energy storage (EES) can support the transition toward a low-carbon, sustainable, reliable, cost-effective, and efficient power system. Previous studies (NY REV, 2015; CPUC, 2015; MassDOER, 2016; RMI, 2015; EPRI, 2010; Sandia, 2008; EC-JRC, 2013; ARENA, 2015; Shcherbakova *et al.*, 2014), and many others, aim to evaluate EES. Accurately valuing EES projects helps inform system operators, distribution network operators, generators, suppliers, regulators, and policy-makers to make decisions to efficiently allocate resources to modernize the electricity grid.

This study focuses on grid-scale EES projects in Great Britain and evaluates them using a social cost benefit analysis framework. Great Britain created the Smarter Network Storage (SNS) Project, the first commercially-deployed, multi-purpose grid-scale battery in the country, and it has been selected as the case study for this research because its empirical results from years of trials are well documented. Previous studies evaluating the benefits and costs of the Smarter Network Storage project include Greenwood *et al.*, (2015), Perez *et al.*, (2016), SNS (2016a), Newbery (2016), and SNS (2013a). These studies have modelled energy storage from a business case perspective or in a future-state of the power system dominated by renewables and distributed energy resources; however, this study evaluates energy storage projects from society's perspective and during the transition period of the power system.

In order to facilitate this transition of the power system, the Office of Gas and Electricity Markets Authority (OFGEM) established the Low Carbon Network Fund, a £100 million per annum (p.a.) fund – which ran for 5 years from April 2010 to March 2015 - to support clean energy demonstration projects sponsored by Distribution Network Operators (DNOs).¹ One such DNO, UK Power Networks (UKPN) established the Smarter Network Storage project in 2013 to showcase how EES could be used as an alternative to traditional network reinforcements and bring carbon emission reduction to the electricity grid. The Smarter Network Storage project deployed a lithium-ion battery with 6 megawatts (MW) and 10 megawatt-hours (MWh) of power and energy, respectively, at the Leighton Buzzard Primary substation to offset the need for an additional sub-transmission line to alleviate capacity constraints.

This paper seeks to examine the empirical trials from the Smarter Network Storage project through the lens of a social cost benefit analysis to evaluate publicly sanctioned investments in grid-scale EES in Great Britain. The social cost benefit analysis framework answers the fundamental question of whether or not society is better off after making the investment in grid-scale EES. The uncertain benefit and cost streams are evaluated through a Monte Carlo simulation and then arranged through a discounted cash flow to provide a net present social value of the investment.

The paper is organised in the following manner. Section two provides a brief explanation for the impetus of deploying the Smarter Network Storage project and a methodology for evaluating its impact on society. Section three introduces the economics of EES and how the costs may vary over

¹ For more information: Office of Gas and Electricity Markets authority. "Low Carbon Networks Fund." Available at: <https://www.ofgem.gov.uk/electricity/distribution-networks/network-innovation/low-carbon-networks-fund>

time. Section four unveils the universe of benefit streams associated with EES projects and how to simultaneously capture those benefits. Section five combines the analysis of the costs and benefits, and discusses the implications of the net present value results. Section six lays out the conclusion and offers insights into policy recommendations for enhancing the value of EES through electricity market reforms.

2. Applying a Social Cost Benefit Analysis Methodology to Electrical Energy Storage Projects

2.1 The Capacity Problem

Electricity supply in Great Britain is composed of four key sectors: generation, transmission, distribution, and suppliers. The electricity generation is largely open to competition in the wholesale capacity, energy, and ancillary service markets. The transmission system is operated by National Grid, who is tasked with balancing the supply and demand for electricity on the transmission power network. Distribution companies (DNOs) participate in regulated activities that are responsible for providing reliable electricity to local distribution network planning areas. Both the transmission and distribution companies are regulated by Ofgem. Suppliers are tasked with purchasing energy in the wholesale market and selling it to end-use customers in a competitive market where customers can choose their supplier to provide them with electricity. Suppliers are legally unbundled from the distribution and generation sectors, and asset ownership in the transmission sector is unbundled from the rest of electricity supply.

Within this electricity supply chain is the Leighton Buzzard Primary substation, an asset owned by UKPN and a bottleneck for providing reliable power to customers in the distribution network. Leighton Buzzard is a city located in Bedfordshire, England and holds a population of approximately 37,000 people. The current Leighton Buzzard primary substation design includes a 33/11kV substation and two 33kV circuits, each with a rated thermal capacity of 35.4 MVA. Due to cold snaps in the winter, UKPN experiences its peak demand for electricity in the winter insofar that the local peak demand surpasses the 35.4 MVA capacity limit. In fact, peak demand at Leighton Buzzard has exceeded firm capacity limits between 9 and 37 days in each of the last five years (SNS, 2013b). **Figure 1** (SNS, 2013b, p.15) illustrates this capacity problem dating back to December 2010.

Figure 1: Load Profile during Two High Demand Days at Leighton Buzzard

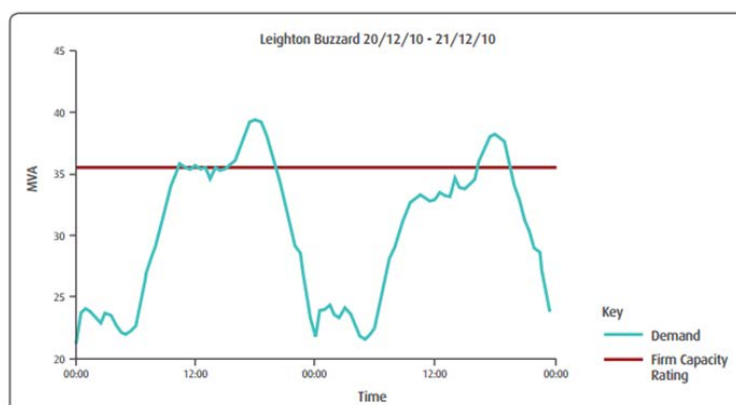

To alleviate the current capacity constraints, the Leighton Buzzard substation is able to re-route 2 MVA of electricity supply. This transfer capacity from neighbouring sections of the distribution network has successfully resolved the peak demand problem in Leighton Buzzard in the short-term; however, it is costly and does not avert the larger issue of growing peak demand over the long-term. Thus, UKPN sought to investigate two potential long-term solutions to the capacity constraint.

2.2 The Two Options for Network Reinforcement

The first option is the conventional approach that DNOs like UKPN would historically choose using least-regrets investment criteria. This option includes building new distribution infrastructure to support the growing electricity needs. For UKPN, this conventional solution for network reinforcement includes building an additional 33kV circuit connecting to the 132/33kV Sundon Grid and a third 38 MVA transformer located at the Leighton Buzzard substation. This reinforcement would provide an additional 35.4MVA step change in firm capacity at Leighton Buzzard, which is significantly above predicted capacity requirements for the medium-to-long term (SNS, 2013b).

The second option is often referred to as a Non-Wires Alternative (NWA) investment because it need not require the expansion of the wires on the electricity grid. Rather, UKPN could build an EES device at the site of the substation to alleviate the capacity constraints. The EES would discharge electricity during times of peak demand to alleviate stress on the electricity grid, and then charge during times of low demand. The EES would be configured and dispatched in a manner to offset the need for the conventional upgrade.

Figure 2 (SNS, 2013b, p.15) compares the two options for network reinforcement. On one hand, UKPN could build a third circuit (illustrated by the hashed line) between the 132/33 kV Sundon grid and the 33/11kV Leighton Buzzard substation. On the other hand, UKPN could build an EES device (illustrated by the green schematic) to offset the need for the conventional upgrade.

Figure 2: Comparing the Two Options for Network Reinforcement

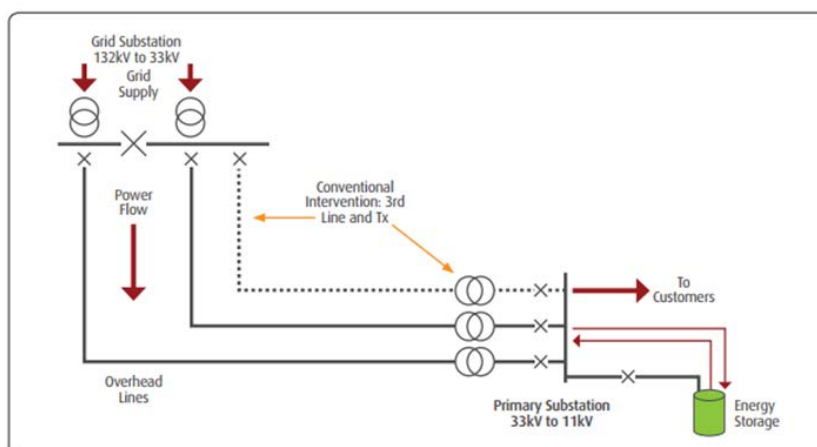

Using financial resources from the Low Carbon Network Fund, UKPN opted to choose the latter solution and build the EES device in 2013, called the Smarter Network Storage project. The EES device for the Smarter Network Storage project was a lithium-ion battery (developed from a lithium-

manganese blend) of the size 6MW/7.5MVA/10MWh.² The battery is composed of 50,688 Samsung DSI battery cells and occupies the land area of approximately three tennis courts (SNS, 2013b).

In addition to deferring the upgrade for capacity, the Smarter Network Storage project sought to realise additional benefits from building a battery by participating in the wholesale power markets and providing location-specific and system-wide services. Due to the unbundling regulations in the UK for DNOs, the Smarter Network Storage project is owned by UKPN³ but it is operated by Smartest Energy and its aggregator is Kiwi Power. Since 2013, UKPN has recorded empirical results from testing and trialling the battery as it actually performs while interconnected to the grid. Using the empirical trial runs, this paper seeks to evaluate the decision to invest in EES from a social cost benefit analysis perspective.

2.3 Evaluating the Options through a Social Cost Benefit Analysis

The social cost benefit analysis assesses future grid investments through a quantitative decision model from the perspective of society as a whole rather than analyse private investments through various business models. The social cost benefit analysis framework is an effective tool for evaluating the change in social welfare from the publicly funded Smarter Network Storage. Therefore, a full social cost benefit analysis should be able to address the impact of an EES project on economic efficiency and equity (Domah and Pollitt, 2001).

Galal *et al.* (1994) identify three main agents in society: consumers, private producers and government. When applying their framework to the electricity supply chain for the Smarter Network Storage project, the agents in society include OFGEM, National Grid, UKPN, consumers, suppliers, and developers. Within electricity markets, deploying a battery would provide different revenue streams for each agent, hence requiring a different business model subject to the individual agent's value proposition. However, the social cost benefit analysis takes a more holistic perspective looking across the various agents of the energy supply chain, incorporating market-based value streams and non-market shadow prices. This tailored social cost benefit analysis framework is illustrated in **Equation 1** and **Equation 2**.

Equation 1: Social Cost Benefit Analysis

$$\Delta SW_t = \sum_i (V_t^i) + \sum_j (\lambda_t^j) - \sum_k (C_t^k)$$

ΔSW_t = The annual change in the social welfare before and after the investment in the battery

V_t = The annual market-based value to society

λ_t = The annual non-market based value to society determined by shadow prices

² MW is a measurement of the real power capacity of the battery. Mega Volt-Ampere (MVA) is a measurement of the apparent power capacity, which includes both real and reactive power capacity. MWh is a measurement of the energy capacity of the battery.

³ Non-distribution business activities, such as income generation from storage projects, are limited by de minimis restrictions specified in the distribution licence. These restrictions mean that turnover from and investment in non-distribution activities must not exceed 2.5% of DNO business revenue or licensee's share capital respectively. (SNS, 2014)

C_t = The annual costs incurred by society

$i = i^{th}$ annual market based value

$j = j^{th}$ annual non-market based value

$k = k^{th}$ annual cost

Equation 2: Net Present Value Analysis

$$NPV = \sum_{t=0}^T \left[\frac{1}{(1+r_t)^t} * \Delta SW_t \right]$$

NPV = The Net Present Value of the project

r_t = the discount rate, determined by the weighted average cost of capital at time (t)

t = the number of years

T = the terminal year of the project

The use of the sigma notation is critical to the social cost benefit analysis because the time dimension for the benefit and cost streams extend through the life of the battery project. This enables the coupling of a social cost benefit analysis with a lifecycle assessment to evaluate the techno-economic performance of the battery. In addition to the lifecycle assessment, the social cost benefit analysis will require the use of discounted annual cash flows to determine the net present value of both the benefits and costs.

Moreover, note the removal of all transfer payments from one agent to another within society. Transfer payments are the exchange of financial claims in which there is no net value generated to society. The need to remove transfer payments induces a more critical examination of project cash flows which rely on taxation, subsidies, duty tariffs, and improvements in the cost of financing because these mechanisms may merely involve the transfer of resources from one agent to another within society. In **Section 4**, certain benefit streams are also omitted from the analysis because they can be classified as transfer payments.

For the lifecycle assessment of the social cost and benefit streams, the discount rate is determined by the pre-tax weighted average cost of capital (WACC)⁴. The pre-tax WACC removes the impact of taxation from the financial analysis (consistent with the view on transfer payments) and values the risk and uncertainty associated with the EES project. SNS (2013a) established the cost of equity at 7.2%, the cost of debt at 3.8%, and the debt-equity ratio at 62%; therefore the pre-tax WACC in real £ terms is 5.09%. For this analysis, the discount rate was varied between 3.0% (social discount rate) and 7.2% (cost of equity) to test its impacts on the NPV of the Smarter Network Storage project. All values in this report are presented as £2013, unless otherwise noted.

The social cost benefit analysis framework adapted to this study from Galal *et al.* (1994) includes the use of a counterfactual (opportunity cost) such that the calculated NPV guides investments in EES

⁴ Pre-tax WACC = (Pre-tax cost of equity * percentage of equity) + (pre-tax cost of debt * percentage of debt)

relative to other solutions. Using the Kaldor-Hicks compensation principle, the investment in the Smarter Network Storage project would be deemed worthwhile to society if $NPV > 0$. Such a result would warrant that the investment was net-beneficial to society (Free, 2010). On the other hand, if $NPV < 0$, this would signify that the investment was net-costly to society.

2.4 Incorporating Risk and Uncertainty with Monte Carlo Simulations

A social-cost benefit analysis is a comprehensive tool for project appraisal and policy assessment from the perspective of society. Incorporating risk and uncertainty into that analysis enhances the reliability of the calculated NPV because the benefits and costs are not deterministic values but rather subject to variation under different future scenarios. In the case of evaluating the Smarter Network Storage project, many variables (including the cost of storage, the market price for wholesale ancillary services, the energy market price, the social cost of carbon, the growth of distributed generation, etc.) are stochastic and vary significantly with uncertainty in future reforms of the electricity market and policy settings, etc. Risk and uncertainty analyses based on Monte Carlo simulation can be useful because it is meaningful to attach statistical distributions to the variables inputted into the social cost benefit analysis. It is particularly useful in the case of new technologies where both benefit and cost streams are highly uncertain.

A Monte Carlo simulation is computer-based technique that uses statistical sampling and probability distribution functions to simulate the effects of uncertain variables (GNZ, 2015). The sensitivity of the social benefits can be modelled through a normal distribution, using the expected value of the benefit and a confidence interval described in **Equation 3**. The sensitivity of the social costs is modelled using a uniform distribution.

Equation 3: Normal Distribution for Assessing Social Benefits

$$f(x|\mu, \sigma^2) = \frac{1}{\sqrt{2\pi\sigma^2}} e^{-\frac{(x-\mu)^2}{2\sigma^2}}$$

μ = the expected value of the benefit

σ = the standard deviation of the benefit value

x = the simulated outcome of the benefit value

The Monte Carlo simulation is executed for 10,000 multi-dimensional trials. The Monte Carlo simulation was applied to each of the eight benefit streams and to each of the six costs elements, and incorporated the variation in the lifetime of the battery and the discount rate.

3. The Social Costs of an Electrical Energy Storage Project

The costs for EES are not well-defined, like more mature power electronic devices. Typically, the costs vary by type of EES technology, the power and energy capacity, and the use-case. This section establishes a clear and consistent framework for capturing all the lifecycle costs of EES and then applies it to the Smarter Network Storage project.

The Smarter Network Storage project gathered funding from a number of public-private sponsorships totalling £16.8 million. It was determined that approximately £5.4 million was directed to “first-of-its-kind-cost” which includes the overhead inherent in measuring, monitoring, and

reporting the trials of the battery tests. The remaining costs were then attributed to capital expenditures and operating expenditures. A degradation analysis is also included to analyse the performance of the battery throughout its lifespan.

The cost of financing of the battery is removed from the analysis because it is a transfer payment between the battery owner and the investor. The taxes and tax shield incurred by the upfront investment and the accelerated depreciation and tariff duties are not pure social costs. These financial benefits and costs are transferred between different agents of society and do not pose any net value to society.

3.1 Capital Expenditures

The capital expenditures of a lithium ion battery pertain to the battery cells, the battery pack, the balance of system, the soft costs, and the engineering, procurement and construction (EPC). A review of studies, including (GTM, 2016; ESA, 2015; BNEF, 2017; RMI, 2015; DOE, 2013), provided a comprehensive breakdown of those costs; but, they also showed some incongruences in the cost of batteries, with some sources showing costs in £/kWh and other sources showing costs in £/kW. The following discussion parses out the intricacies of the costs of EES devices and normalizes the costs to the size of 6 MW / 10 MWh for the Smarter Network Storage project.

3.1.1 Battery Cells and Pack

The battery cells and packs are at the core of the battery energy storage system (BESS). The Smarter Network storage project acknowledges that the main cost driver of the cells and packs is the power-to-energy ratio of the storage device. Therefore, costs of these components are often reported as £/kWh. It is estimated that an identical battery with the size of 6 MW / 6 MWh would have 60-65% of the total capital expenditure of the 6 MW / 10 MWh battery (SNS, 2016b).

The Smarter Network Storage project includes 192 Samsung DSI lithium-manganese battery cells connected in series per pack. These packs were then placed into 264 trays per rack, with 22 racks connected to each 500 kW of the storage management system. For a 6 MW battery, the result is a total of 50,688 Samsung DSI battery cells that are integrated into battery packs.

3.1.2 The Balance of System

The balance of system for the BESS includes just the hardware costs for the equipment to support the functionality of the battery cells and packs. The balance of system costs include the rectifier and the bi-directional inverter because the battery operates in direct current (DC) but charges from and discharges to the grid, which operates on alternating current (AC). The balance of system costs include power conversion systems, enclosures, containerization, safety equipment, system packaging, and any other system operating technologies. The balance of system costs are often reported in £/kW because the equipment is designed to support the maximum power output of the battery.

3.1.3 Soft Costs & Engineering Procurement and Construction (EPC)

The soft costs include the customer acquisition, customer analytics, industry education, permitting fees, supply chain costs, and installation labour. As evidenced by other more mature technologies such as photovoltaics, soft costs can decline rapidly as standardization reduces the permitting fees, labour-hours, and supply chain costs. As the EES industry matures, the soft costs will likely follow an asymptotic cost decline curve.

The engineering, procurement, and constructions (EPC) costs largely included civil engineering, procurement of land for use, and logistics for construction of the site. The need to construct an entire building to house the BESS became the driver for the EPC costs. For the Smarter Network Storage project, a building equivalent to the size of three tennis courts was constructed to safely and securely operate the 240 tonnes of equipment.

3.2 Operating Expenditures

The BESS has annual operating expenditures that include system upkeep and electricity purchasing. Upkeep costs include inspection & maintenance, spare parts, facilities costs, insurance, management & administration, control systems, and risk management & energy trading. Regardless of the utilisation of the BESS, these upkeep costs are relatively equivalent year-over-year in real £ terms. **(See Appendix B)**

The BESS has electricity purchasing costs that include tariffs and charges to interconnect to the electricity grid and provide wholesale power services. These costs include the wholesale energy price during charging of the battery, low voltage auxiliary consumption, feed in-tariff, balancing services use of system charges, residual cash flow and reallocation cash flow, contract for differences operational levy, and daily service fees. These costs are directly a function of the utilisation and type of balancing service provided by the BESS; thus, they will fluctuate year-over-year as the performance and dispatch of the battery and the wholesale energy price change over its lifespan.

Operating costs that have been omitted from this analysis include the DNO fixed charge, the DNO capacity charge, and tolling because they are transfer payments. The DNO fixed charge and capacity charge are reflective of distribution use of system (DUoS) fees, which are fees incurred by every grid-interconnected device to the distribution system of UKPN. Regardless of the Smarter Network Storage project, UKPN would still be able to recover the same distribution system costs by levying the DUoS on other grid-interconnecting devices. In the same vein, tolling is a transfer fee that the UKPN levies on Smartest Energy (the battery operator) and Kiwi Power (the battery aggregator) to operate its equipment (in accordance with the unbundling rules for DNOs).

3.3 Degradation Costs

Additional analysis is conducted to show degradation costs as a function of the utilisation and age of the BESS. The algorithm of the degradation model includes cycle frequency, length, and characterization; therefore, providing different wholesale market services may exhibit a unique degradation of the battery. The results from the degradation analysis unveiled that the battery has a Coulombic efficiency of 0.999954 when cycling between 0 - 68% of its depth of discharge (Perez *et al.*, 2016). This would result in approximately a 4.6% degradation of the battery cells and pack per 1,000 cycles. When the battery reaches 75% of its rated nominal energy capacity, the battery is determined to have reached its full lifespan and needs to be decommissioned, justified by the growth of the battery's internal resistance and subsequent heat loss (Perez *et al.*, 2016).

In addition to degradation from the utilisation of the battery, there is also degradation from its age after the manufacturing date. This wear-and-tear affects the energy capacity of the battery cells, packs, and balance of system. SNS (2013a) calculated that the annual energy capacity degradation per annum was 0.5%. **Equation 4** calculates the energy capacity degradation of the battery and **Equation 5** calculates the lifespan of the battery.

Equation 4: Energy Storage Capacity Degradation

$$EC_t = EC_0 - \sum_{t=0}^{T_{lifespan}} \left[\left(\eta * \frac{4.6\%}{1000} \right) + \check{D}_t \right]$$

Equation 5: Battery Energy Storage System Lifetime

$$T_{lifespan} \text{ occurs when } 0.75 * EC_t = EC_0$$

EC_t = the energy storage capacity (MWh) at time (t)

EC_0 = the energy storage capacity (MWh) at the initial time of the manufacturing date

η = the number of cycles

\check{D}_t = the annual degradation of the energy capacity of the BESS

$T_{lifespan}$ = the lifetime of the EES project (years)

Figure 3 illustrates the degradation of the Smarter Network Storage project over time. Depending on the utilisation of the battery and the annual wear and tear on the system components, the lifespan of the battery ranges from 10 to 14 years. This lifespan is critical to the lifecycle assessment of the battery, and the range is incorporated into the Monte Carlo simulations for the social cost benefit analysis.

Figure 3: Energy Storage Degradation

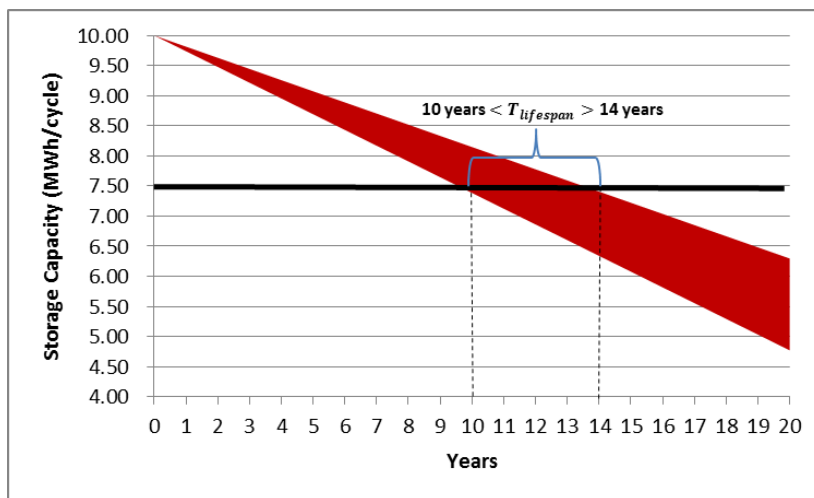

Not only does the energy storage capacity degrade with time and utilisation, but the roundtrip efficiency of the battery degrades as well. At the beginning of life, the AC-AC roundtrip efficiency⁵ of the battery is 87% (SNS, 2012), with a symmetrical efficiency between charging and discharging. The Smarter Network Storage battery is estimated to experience annual efficiency degradation from the cells, pack, and the balance of system of 1% per annum. Additionally, the battery is projected to

⁵ AC-AC roundtrip efficiency is the ratio of the energy put into the battery during charging (MWh) and the energy that can be retrieved when the battery is discharging (MWh). It includes losses pertaining to inverting and rectifying power between AC and DC.

experience efficiency degradation from utilisation at the value of 1% per 1,000 cycles (SNS, 2013a). The efficiency degradation is critical to assessing the operating costs of the battery because these energy losses require the battery to draw more electricity from the grid to provide equal output services; thereby, resulting in higher operating costs.

Equation 6: Electrical Energy Efficiency Degradation

$$\epsilon_t = \epsilon_0 - \sum_{t=0}^{T_{lifespan}} \left[\left(\eta * \frac{1.0\%}{1000} \right) + \check{D}_t \right]$$

ϵ_t = the roundtrip electrical efficiency (%) at time (t)

ϵ_0 = the roundtrip electrical efficiency (%) at the initial time of the manufacturing date

\check{D}_t = the annual degradation of roundtrip electrical efficiency of the battery

The BESS also draws power from the grid to operate its auxiliary equipment to monitor the state of charge of the battery, power communication signals with the grid and grid operator, and power the telemetry equipment with the battery operator. This “parasitic load” is 29.2 kW and reduces the rated power output of the BESS in providing power services to the bulk power system (SNS, 2012).

3.4 Social Costs Results

The social costs of the Smarter Network Storage project vary over time as the industry exhibits economies of scale and the learning curve. Therefore, the costs have been dissected between the costs likely incurred by the Smarter Network Storage project in 2013 and the projected cost decline for identical battery installations deployed between 2017 and 2020. In agreement with a range of studies (GTM, 2016; ESA, 2015; BNEF, 2017; RMI, 2015; DOE, 2013), the total social costs in 2013 are £10.70 million and drop to between £9.10 and £7.49 million before the end of the decade. **Figure 4** shows the breakdown of each cost component and how the costs are projected to decline over time.

Figure 4: The Social Costs of the Smarter Network Storage project (£ thousands)

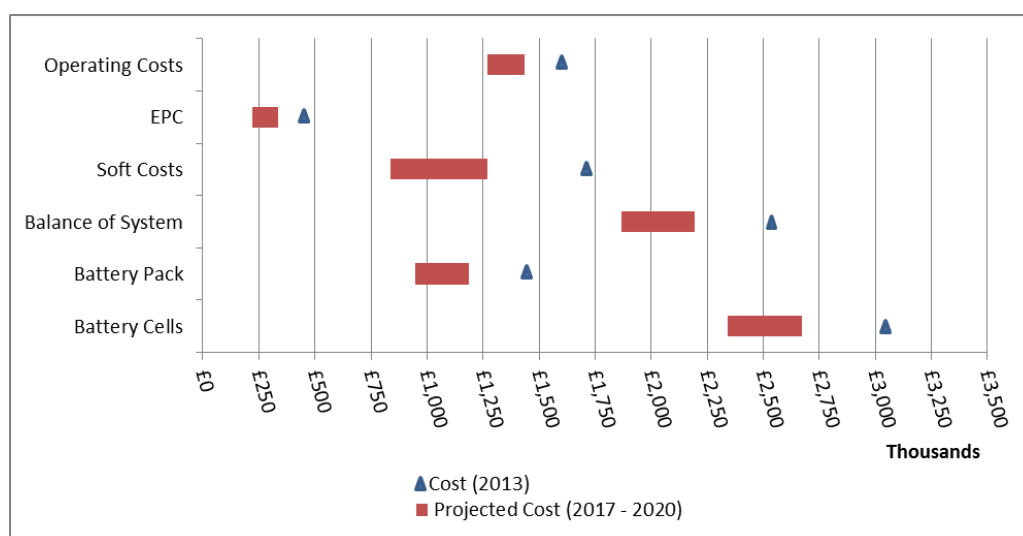

For the Monte Carlo simulation, the future costs are presented as a uniform distribution function to reflect that dynamic changes in the costs of the BESS. While most studies provide the 1st and Nth cost

of BESS, the approach used in this analysis does not overlook that the real cost of BESS during the transition of the electricity grid is between the 1st and Nth deployment, closer to the average or median between the two.

4. Determining the True Benefits of Electrical Energy Storage

4.1 The Multiple Services provided by Electrical Energy Storage

EES can provide multiple services to multiple markets. A comprehensive literature review of studies (NY REV, 2015; CPUC, 2015; MassDOER, 2016; RMI, 2015; EPRI, 2010; Sandia, 2008; EC-JRC, 2013; ARENA, 2015; Shcherbakova *et al.*, 2014) was undertaken to collect the universe of benefits from EES projects. These locational and system-wide benefits are then organized by their beneficiary, including National Grid, OFGEM, UKPN, Developers, Customers, and the Wider Society. The categories that are underlined in **Table 1** are classified as true social benefit streams from the Smarter Network Storage project.

Table 1: The Universe of Social Benefits from Electrical Energy Storage

Category	Definition
Bulk Power System (National Grid, OFGEM, Developers)	
Enhanced Frequency Response	The response to system frequency signals in less than 1 second to restore electricity supply-demand equilibrium.
<u>Primary Frequency Response</u>	The response to system frequency signals at 1 second from the frequency signal to restore electricity supply-demand equilibrium.
Secondary Frequency Response	The response to system frequency signals at 10 seconds from the frequency signal to restore electricity supply-demand equilibrium.
Frequency Control by Demand Management	The response to system frequency signals by modulating demand in order to restore electricity supply-demand equilibrium.
High Frequency Response	The response to system frequency signals by reducing generation output or consuming more power to restore supply-demand equilibrium.
Fast Reserve ^a	Generation capacity that serves load at a ramp rate of 25 MW within 2 minutes of an unexpected contingency event, such as an unplanned generation outage.
Short term operating reserve (STOR) ^a	Generation capacity that serves load within 5 minutes of an unexpected contingency event, such as an unplanned generation outage.
Triad Avoidance (Transmission Deferral) ^c	National Grid recovers the cost of the transmission system through demand charges for the three half hours in a year with the most transmission congestion, known as triads.
Transmission Congestion & Loss	The reduction in congestion and loss on the transmission network to improve the efficiency of locational marginal prices at the nodal level.
<u>Energy Arbitrage (Trading)</u>	The purchase of wholesale electricity when the price of energy is low and sale of wholesale electricity when the prices are high.
Capacity Market	Generation capacity to provide the necessary reserve margin for system resource adequacy.
Distribution System (UKPN, OFGEM)	
<u>Distribution Deferral^d</u>	Delaying, reducing the size of, or entirely avoiding utility investments in distribution system upgrades necessary to meet projected load growth on specific regions of the grid.
<u>Network Support^b</u>	The portfolio of services including reactive power support, power quality, voltage control, and reduction of distribution losses. These services make the distribution system more cost-efficient to operate and upkeep.
<u>Security of Supply</u>	Dispatching stored energy to the grid during peak conditions to reduce the stress of capacity constraints on the distribution system (i.e. peak shaving).
<u>Terminal Value of the Asset</u>	The end of life asset value that can be extracted and utilised to provide options and flexibility to distribution network operators.
Customer Service and Bill Savings (Suppliers)	
Reliability (Avoided Outage Costs) ^d	The measure of the grid's ability to serve the load of all its customers at the level of its intended purpose. Islanding sections of the grid or providing

Category	Definition
	uninterruptable backup power supply are forms of local reliability.
Resiliency (Black Start) ^d	In the event of a grid outage, black start generation assets are needed to restore operation to larger power stations in order to bring the regional grid back online. Energy Storage has black start capabilities to reduce the duration of the customer outage.
<u>Reduced Distributed Generation Curtailment</u>	Minimizing the curtailment of electricity generated from behind-the-meter wind and solar systems to increase the capacity factor of distributed generation.
Time-of-Use (TOU) Bill Management ^d	Customer bill reduction by minimizing electricity purchases during peak electricity-consumption hours and shifting these purchases to periods of lower rates.
External (Society)	
<u>Carbon Abatement</u>	The reduction of carbon emissions from the power sector and its adhering social costs pertaining to climate change.
Environmental Benefits (Water, Land, Criteria Pollutants)	The reduction in environmental costs such as water usage, land use, and emissions of other criteria pollutants.
Fuel Price Volatility	The avoided risk and uncertainty from the volatile market price of commodities such as coal, oil, and natural gas.
Physical and Cyber Security	The reinforcement in system security and distribution system architecture to reduce the vulnerability from physical and cyber threats to the electricity grid.

^a National Grid (2017a), ^b SNS (2016a), ^c National Grid (2015), ^d RMI (2015)

The Smarter Network Storage project was the first grid-scale storage project in the UK to demonstrate the simultaneity of some of these multiple services. However, it is not possible for an EES device to provide all of these aforementioned services simultaneously. Some of these services would double count the benefits of an EES project or the participation in one service would disqualify the EES from participating in another service. Therefore, only a handful of these benefits can truly be stacked together in the social cost benefit analysis.

4.2 Stacking the Benefits

As evidenced by the Smarter Network Project trials, it is possible for EES to provide multiple ancillary services and couple that with energy market services. As illustrated in **Figure 5** (National Grid, 2017c, p. 1), National Grid declares that EES can provide enhanced, primary, and secondary response, and then provide reserve services, in sequence following a contingency event (0s represents the time of the contingency event on the grid). During the trial periods, the Smarter Network Storage project participated in primary frequency response and STOR. If EES were to currently bid into these multiple ancillary service markets, it could not do so as a single package; but rather, it would have to bid into each ancillary service market separately (Greve and Pollitt, 2016).

Figure 5: National Grid Ancillary Services

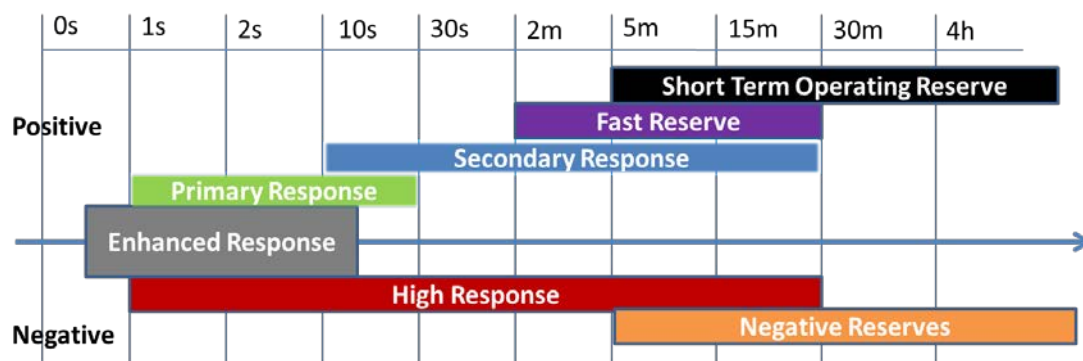

The trials also verified that certain value streams cannot be bundled together or do not provide net benefits to society. These value streams have henceforth been removed from the calculation of the true social benefits of the Smarter Network Storage project. This sub-section describes those services not included as a social benefit.

- **Enhanced Frequency Response.** EES can effectively provide frequency response because it pairs an energy neutral technology with an energy neutral service. National Grid established this new market to provide response to frequency signals within 1 second. However, the Smarter Network Storage project did not qualify for this service due to technical constraints.
- **Secondary Response.** The secondary response market allows an EES device up to 10 seconds to respond to a frequency signal, and it must provide that grid support for up to 30 minutes. Due to the nature of the Smarter Network Storage project bidding its entire capacity into the primary frequency response market; it could not also supply secondary response services.
- **Frequency Control by Demand Management.** National Grid aims to achieve 30-50% of system balancing needs from demand side measures by 2020 (OFGEM, 2015). EES can participate in frequency control by demand management by modulating its charging from the grid; however, participating in Primary Frequency Response precluded the Smarter Network Storage project from also providing this service.
- **High Response.** Typically, National Grid does not allow developers to bid into upward and downward reserves of ancillary markets simultaneously. EES has the technical ability to provide upward and downward reserve, but additional electricity market reforms are needed to fully realize the benefits of this service. Therefore, by bidding into Primary Frequency Response, the Smarter Network Storage project cannot bid into High Response.
- **Fast Reserve.** EES can participate in Fast Reserve through aggregation with other distributed energy resources. The Smarter Network Storage project opted to trial primary frequency response and short term operating reserves, which prevented the ability to provide fast reserve services.
- **Short term operating reserve (STOR).** The Smarter Network Storage project qualified for providing STOR services and received payments for availability and utilisation; however, the revenue from these payments is less than the marginal costs to provide the service insofar that it is uneconomical for the battery project to provide this service moving forward (SNS 2016d).
- **Triad Avoidance.** National Grid recovers its transmission costs through Transmission Use of System (TUoS) payments, determined by the amount of electricity consumed by each user during triads. If the Smarter Network Storage project avoids a triad, other agents of society would be forced to pay more during the triad so that National Grid can make its specified return on its transmission investments. Therefore, triad payments are predominantly manifestations of transfer payments and are not included as a social benefit. There is no direct evidence that the Smarter Network Storage project would contribute to actual deferral of any transmission upgrades.
- **Transmission Congestion and Loss.** EES could reduce transmission congestion and loss costs if it is located in an area that exhibits these network inefficiencies. The Smarter Network Storage project does not provide incremental benefits beyond the traditional network

upgrade except in the case of utilizing distributed generation, which is already quantified in Reduced Distributed Generation Curtailment.

- **Capacity Markets.** The capacity market is designed to ensure sufficient, reliable capacity is available on the bulk power system by providing guaranteed contractual payments to encourage investment in new and existing generation capacity (EMR, 2017). EES can participate in the capacity market; however, the capacity market is unlikely to provide a viable revenue stream for most battery operators because they must compete against mature technologies and would be restricted to the role of a stand-by plant, thereby limiting its ability to provide other services such as arbitrage, local security of supply, and Triad avoidance. This was evidenced by the fact that no new storage assets were awarded capacity market contracts for the 2019/2020 auction (Weightman and Arora, 2016) and only 3GW (or 6% of the capacity market) of energy storage cleared the 2020/2021 auction (National Grid, 2016).
- **Reliability & Resiliency.** Reliability and resiliency are valuable benefits that can be calculated using an algorithm for value of lost load (VOLL), system average interruption duration index (SAIDI), system average interruption frequency index (SAIFI), and customers experiencing multiple interruptions (CEMI). There is no specific indication that the Smarter Network Storage project would have provided additional reliability and resiliency benefits beyond the conventional distribution upgrade; therefore, this value is deemed negligible.
- **Time-of-Use Bill Management.** Demand charge reduction and time-of-use bill management are possible value streams for behind-the-meter EES; however, this project is owned by UKPN, located at the Leighton Buzzard substation, and is operated to meet the needs of the grid rather than customer-specific needs. Under certain circumstances, operating the grid more efficiently may lead to customer bill savings, but these benefits are already captured and recorded in Network Support.
- **External Benefits** (not including carbon abatement). NREL (2015) attempted to value the external benefits of EES to society through environmental benefits such as reduced water consumption, land-use, and criteria pollutants by enabling a cleaner generation mix on the electricity grid. Enabling renewable generation also reduces the reliance on commodity-driven fuels (coal, oil, natural gas), such that EES could reduce the market exposure to fuel price volatility. Moreover, PNNL (2015) explains that EES deployed as a distributed energy resource may be able to provide physical and cyber security benefits to the grid by shifting the paradigm from centralized generation to an array of distributed assets, thereby reducing the vulnerability of certain targets to the grid. These benefits are determined to be out of the scope of this particular study due to the lack of data validation and substantiality for its parameters for the Smarter Network Storage project.

As a result, the Smarter Network Storage project can only provide a subset of the universe of benefits available from EES. The social value from the remaining benefits is then optimized, subject to binding constraints.

4.3 Optimizing Multiple Services

In order to successfully and realistically provide these multiple services for multiple stakeholders, the Smarter Network Storage project developed a Smart Optimization and Control System (SOCS) to optimize revenues from its dispatch and scheduling. The SOCS is comprised of a Forecasting Optimization Software System (FOSS) to forecast demand and remunerative markets, and the BESS

to communicate with the grid operators for dispatch into the grid and ensure the battery is in the required state of charge to provide the grid service. The demand forecasting from FOSS is the critical first step in optimizing the set of services and revenues generated by the battery because grid services need to be tendered for weeks-to-months in advance. From the forecasts, the BESS then calculates a multiple linear regression model to optimize the battery dispatch in the multiple service markets (Greenwood *et al.*, 2015). In other words, the BESS is configured to maximize social value with inputs from FOSS and subject to the constraints of the state of charge and security of supply which are defined as follows:

- **State of Charge.** State of charge is the measure of the immediate capabilities of the battery and is analogous to a “fuel gauge” for the battery (Woodbank, 2005). The battery must be at the required level of charge to provide a distinct service to the grid. Participating in one service may preclude the ability for EES to provide another service because the EES will not be in the required state of charge.
- **Security of Supply.** The Smarter Network Storage project was designed to offset the need for conventional distribution reinforcement by reducing the peak demand on the existing grid infrastructure. Therefore, the dispatch and scheduling of the project must always prioritize the security of local supply above all other services in order to maintain the reliability on the grid. The EES shall not be dispatched for any other service that may conflict with its ability to provide security of supply.

The Smarter Network Storage project trialled various combinations of dispatch and scheduling to empirically test against its optimization algorithm and minimize trade-offs between benefit streams. Given the optimization algorithm, market regulations, financial incentives, and contractual agreements, the benefits valued in **Section 5** are determined to maximize social welfare and net present value in the social cost benefit analysis.

5. The Social Cost Benefit Analysis of Electrical Energy Storage Projects

5.1 The Social Costs of the Smarter Network Storage Project

The social costs from **Section 3** have been calculated for 2013 and projected for 2017 to 2020. The present values of the lifecycle costs are presented in **Table 2**. At any point between 2013 and 2020, the probability of realizing these costs is equally likely, thus these values present the bounds for the uniform distribution in the Monte Carlo simulation.

Table 2: The Value of Cost Streams

Social Cost Category	Cost (2013)	Projected Cost (2017-2020)
Battery Cells	£3,010,000	£2,675,000 - £2,340,000
Battery Pack	£1,420,000	£1,185,000 - £950,000
Balance of System	£2,520,000	£2,194,800 - £1,869,600
Soft Costs	£1,700,000	£1,268,200 - £836,400
EPC	£450,000	£335,700 - £221,400
Operating Costs	£1,607,380	£1,437,617 - £1,267,852
Total Social Cost	£10,707,380	£9,096,316 - £7,485,252

5.2 The Social Benefits of the Smarter Network Storage Project

This section discusses the assumptions and calculations of the social benefits (see **Appendix A** and **Appendix C** for further details on the assumptions and calculations). The present values of the lifecycle assessment are presented in **Table 3**. The values are presented in a 95% confidence interval (consistent with the parameters for the normal distribution used for the Monte Carlo simulations) to incorporate real-world risk and uncertainty.

Table 3: The Value of the Benefit Streams

The Social Benefit Streams from SNS	Value with 95% Confidence Interval
Frequency Response	£1,554,608 - £3,878,579
Arbitrage	£272,313 - £552,914
Distribution Deferral	£2,546,250 - £4,019,613
Network Support	£1,152,840 - £2,533,917
Security of Supply	£176,096 - £357,551
Reduced Distributed Generation Curtailment	£67,256 - £529,299
Carbon Abatement	£191,556 - £851,255
Terminal Value of Asset	£293,980 - £485,022
Total Social Benefit	£6,254,899 - £13,208,151

5.2.1 Frequency Response

The system frequency, 50Hz at equilibrium in Great Britain, measures the balance between that supply and demand. If the frequency falls out of the range of 49.5 – 50.5 Hz, there may be damage to the power electronics interconnected to the grid. The Smarter Network Storage project set its automatic response signals to the bounds of 49.7 and 50.3 Hz in order to increase its utilisation for network services. The Smarter Network Storage project participated in static firm frequency response rather than dynamic firm frequency response because it was more cost-effective during the trial period.

During the trial period, the battery was available for over 7,000 hours per annum (p.a.) and utilised by National Grid for this service during two separate events. National Grid compensates frequency response providers with an availability payment for when the unit is committed to providing frequency response and an utilisation payment for when the unit is dispatched for frequency response. In agreement with National Grid (2017b) and Perez *et al.* (2016), the estimated availability payment is £8/MW/h and the utilization payment is £24/MW/h, and the Monte Carlo simulation used a market price fluctuating +/-25% for the availability payment and the utilisation payment, each. Frequency response is the largest revenue stream from wholesale power services, making it a critical feature of the social benefits for grid-scale EES projects.

5.2.2 Arbitrage

During the course of a day, the wholesale energy market price may fluctuate considerably. In Great Britain, wholesale energy market price is calculated using location marginal pricing (LMP), which is a function of the cost of power generation, transmission congestion, and the energy losses from transmission of electricity, and this LMP varies between £30/MWh and £50/MWh (SNS, 2013a).

EES is able to take advantage of the diurnal price fluctuation by charging the battery during times of low prices and discharging during times of high prices, when the EES is not providing other critical grid services. The Smarter Network Storage project participates in arbitrage for approximately 150

hours of discharge p.a. (SNS, 2013a), and the Monte Carlo simulation incorporates a +/-15% price fluctuation at the time of buying and selling electricity, each. The results show that the revenues from arbitrage are significant but not enough to substantiate a grid-scale EES project on its own.

5.2.3 Distribution Deferral

The Smarter Network Storage project was designed to defer the need to upgrade the capacity of the sub-transmission line connecting the Sundon Grid to the Leighton Buzzard primary substation. Therefore, there is value in avoiding the cost necessary to upgrade the distribution circuit and this can be directly valued using the counterfactual: the cost of the conventional distribution upgrade.

The estimated cost for the conventional upgrade would be £6.2 million (SNS 2013a). However, building a sub-transmission line would provide an additional capacity of 35.4 MVA and have an expected life of 40 years; whereas, the Smarter Network Storage project only provides 7.5 MVA and has an expected life of 10-14 years. In order to determine the true benefit of distribution deferral, it is critical to determine the length (in years) of that deferral. **Figure 6** shows peak demand growth juxtaposed with capacity increases from the Smarter Network Storage project. It is concluded that the Smarter Network Storage provides sufficient capacity to accommodate peak demand growth on the circuit throughout its lifespan (despite degradation accounting for the decreasing Smarter Network Storage capacity over time).

Figure 6: Load Growth Forecast for the Leighton Buzzard Primary Substation⁶

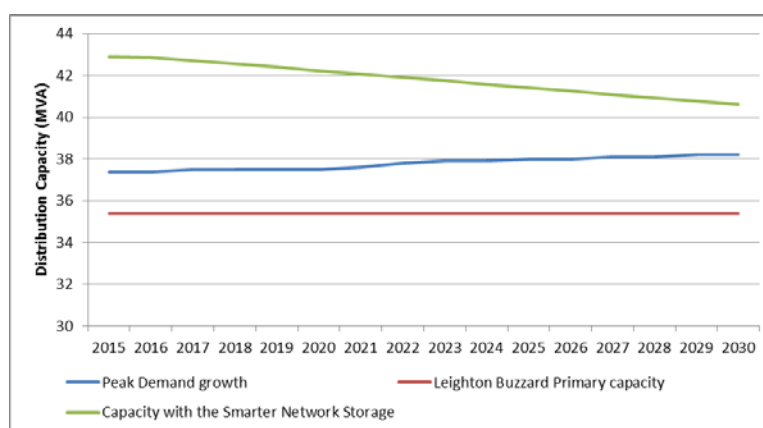

With the battery providing sufficient additional capacity in the near future, the value of distribution deferral is predicated on the lifespan of the battery. The benefit is captured through the avoided cost of the conventional upgrade, which is represented as a series of annual cash flow in an annuity. The annual cash flows are calculated using the discounted cash flow model illustrated in **Equation 7**, with the discount rate equal to the WACC (which had a confidence interval between 3.0% and 7.2%), the present value of £6.2 million, and $t = 40$ years. The present value of that cash flow over the lifespan of the battery (10-14 years) is the value of the distribution deferral, and it is determined that this value is significant in the social cost benefit analysis.

⁶ The Leighton Buzzard Primary capacity and the Peak Demand growth are provided by data from SNS (2013b). The capacity with the Smarter Network Storage project has been calculated using the degradation analysis presented in Section 3.

Equation 7: Discounted Cash Flow Model for an Annuity

$$PV = C * \left[1 - \frac{1}{(1+r)^t} \right] / r$$

PV = the present value of the distribution deferral

C = the annual cash flow

r = the discount rate

t = the number of years

5.2.4 Network Support

During times of local peak demand or peak distributed generation, inductance or capacitance may cause misalignment between the phases of current and voltage. This misalignment reduces the power factor in the circuit, leading to distribution losses and reduced power quality. Network support is defined as the portfolio of benefits pertaining to reactive power support (kVAR), power quality, voltage control, and energy loss reduction in the distribution system.

Demonstration results from the Smarter Network Storage project proved that it can provide these non-market services to the DNO, thereby providing a tangible benefit of system cost-savings. Although a reactive power support market exists for National Grid, this market does not exist at the distribution level. Therefore, these benefits are calculated through the use of shadow prices to value these non-market benefits.

SNS (2016a) calculated that the value of network support for the Smarter Network Storage project in 2030 would be approximately £48/kW-yr. For the Monte Carlo simulation, this value is determined to be an upper bound for today's value of network support, with the expected value and lower bound at -15% and -30%, respectively. The results show that network support from batteries provides a relatively valuable service to society.

5.2.5 Security of Supply

Security of supply (peak shaving) ensures the reliability of adequately supplying electricity to the customer (OFGEM, 2017). Each peak shaving event is characterised by the duration of the event and the maximum power (MVA) needed to reduce the demand to appropriate levels. This value is distinctly different than distribution deferral because it monetizes the wholesale energy market-based benefits associated with peak shaving.

During the trial period, the annual amount of peak shaving required was 97 hours spread across 45 days. During this time, the maximum power required for peak shaving was 5.7 MVA and the annual energy requirement for peak shaving was 141.6 MVAh (SNS, 2016c). The revenue calculation from peak shaving is equivalent to that of arbitrage; the only difference being that peak shaving is an involuntary form of arbitrage. Therefore, EES charges at £30/MWh and discharges at £50/MWh and the Monte Carlo simulation incorporates a +/-15% price fluctuation in each.

5.2.6 Reduced Distributed Generation Curtailments

Distributed generation (DG) is the generation of electricity at or close to the point of consumption and has become increasingly prevalent due to declining prices, customer choice, and backup power, among others. The power grid in Great Britain was designed for uni-directional power flows from centralised generation; however, the advent of DG may create bi-directional power flows on the power grid today. These N-1 conditions are exacerbated during times of high DG production and low electricity demand, hence DG is curtailed.

EES can increase the hosting capacity and reduce DG curtailment, thereby creating a social benefit (Walawalkar *et al.*, 2006). Both the battery and the conventional upgrade may be able to reduce distributed generation curtailment by increasing the hosting capacity of the distribution circuit; however, only the battery enables bi-directional power flows by absorbing excess DG, such that this social benefit is additional beyond the conventional upgrade.

In Great Britain, DG is largely driven by wind and solar, which have a capacity factor of 30% and 11.16%, respectively (Anaya and Pollitt, 2017). Within UKPN's Eastern Power Network (which includes Leighton Buzzard), the curtailment for DG wind and solar is roughly 6% (UKPN, 2017). It is further calculated that grid-scale EES could reduce this curtailment by half (UKPN, 2014). The product of reduced curtailment (MWh) and the wholesale energy market price of £40/MWh (SNS, 2013a) determine the value of the reduced curtailment. Given the large uncertainty surrounding future DG capacity, the Monte Carlo simulations incorporate variability in DG growth, ranging from 5% to 15% per annum, a wholesale energy market price fluctuating +/- 15%, and DG installed capacity of between 4 and 8 MW.

5.2.7 Carbon Abatement

A carbon price is a price applied to carbon pollution to encourage polluters to reduce the amount of greenhouse gas they emit into the atmosphere. To meet its greenhouse gas emissions reduction goals of 80% from 1990 levels by 2050, Great Britain currently uses the European Union Emissions Trading Scheme and Carbon Price Floor. However, the social cost of carbon is used for this project appraisal because it quantifies the damage costs incurred by society from carbon emissions. The social cost of carbon is determined by the Department of the Energy and Climate Change (DECC, 2009)⁷, and prices are converted to £2013 in **Figure 7**.

Figure 7: Social Cost of Carbon Prices

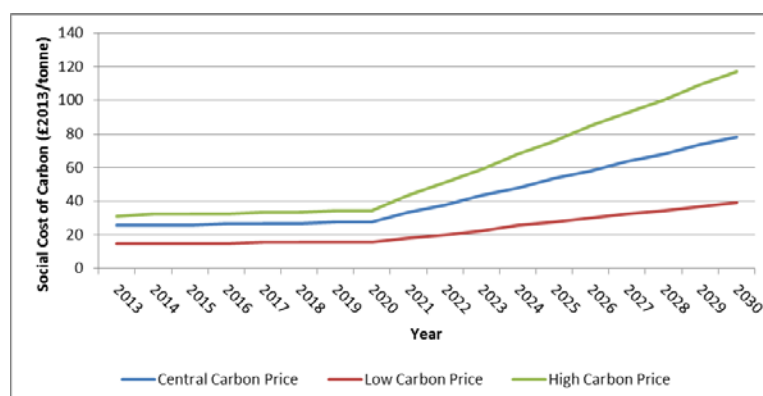

⁷ DECC was the predecessor federal agency to the Department of Business, Energy, and Industrial Strategy

The social cost of carbon is the shadow price for the value of each tonne of carbon dioxide that is abated by the Smarter Network Storage project. It is estimated that this Project abated 1.7 kilo tonnes of carbon dioxide per annum (SNS 2013c); therefore, the product between the quantity of carbon abated and the social cost of carbon is equal to the value of this benefit stream. For the social cost benefit analysis, this avoided cost of emitting more carbon into the atmosphere is algebraically represented as a benefit of the Smarter Network Storage project. The Monte Carlo simulations incorporate the variability in the social cost of carbon.

5.2.8 Terminal Value of the Asset

At the end of the battery life, there still exists some terminal value of the assets, including the balance of plant and civil work. Although a secondary market may exist for the battery cells and pack (which have degraded to the end of their useful life for the application at the Leighton Buzzard substation), such a market is not robust enough for this analysis. The balance of plant and civil construction may have a life that is longer than the cells and pack and have a terminal value that is calculable. If the developers of the Smarter Network Storage project were to replace the battery cells and pack, they may not need to replace the entire balance of plant; therefore, there is direct value attributed to these assets.

Furthermore, the civil works of the Project was designed to incorporate an 8MW / 17MWh battery and included a lease for the land for 99 years (LeightonNet, 2017), creating an *option value* at the end of the original battery's life. At the end of the project life, UK Power Networks has the option to install a new battery, develop another alternative solution, or energy efficiency and distributed generation may cause peak demand to fall below the original capacity of the distribution circuit insofar that no upgrade is required any longer. The *option value* is especially beneficial during the uncertainty of Great Britain's clean energy transition because it increases the choices and flexibility for future solutions.

The terminal value of these assets is calculated using a straight-line depreciation of 18% per annum (SNS, 2013a). The Monte Carlo simulation incorporates the variability in the life of the assets (10-14 years) and a depreciation of +/- 5%.

5.3 Techno-Economic Results of the Smarter Network Storage Project

The eight benefits streams, six cost elements, time horizon, and discount rate were all incorporated into the Monte Carlo simulations to determine the NPV of the Smarter Network Storage project. For **Figure 8** and **Figure 9**, the x-axis is the NPV result and the y-axis is the frequency of that NPV result from the Monte Carlo simulations. As evidenced by the difference in the results from the two figures, lowering the capital costs through economies of scale is the quintessential driver to improving the NPV of grid-scale EES projects.

Figure 8 shows by way of comparison that, for similar projects installed with the 2013 costs (i.e. with only the benefits, lifetime and discount rate subject to uncertainty), the expected value would be -£1,484,420 and the median would be -£1,469,634. Furthermore, the results show that of the 10,000 trials, 1% had a positive NPV and 99% had a negative NPV.

Figure 8: NPV of Identical Smarter Network Storage projects Installed in 2013

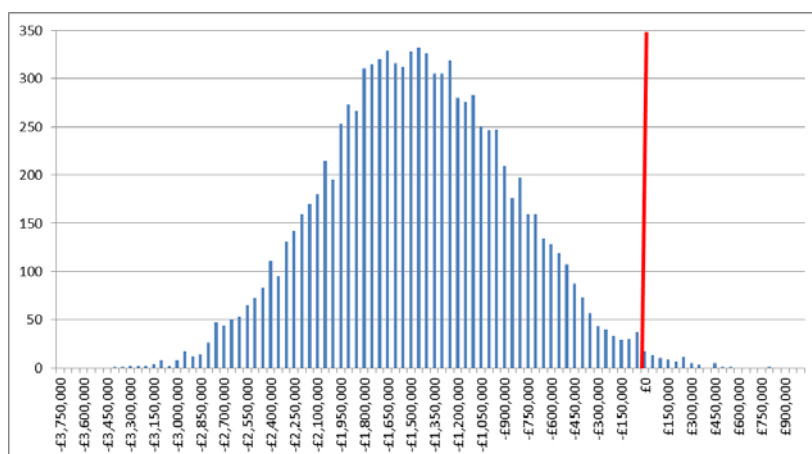

These results prove that, in 2013, the social costs outweighed the benefits. Such an investment would not have not likely passed the Kaldor-Hicks criterion, due to then high capital costs of the battery technology. The simulation also shows that a positive NPV would only happen under a limited number of extremely positive outcomes.

Figure 9 shows that, if the project was installed any time between 2017 and 2020, the expected value would be £931,231 and the median would be £922,654. Furthermore, the results show that of the 10,000 trials, 94% had a positive NPV and 6% had a negative NPV.

Figure 9: NPV of Identical Smarter Network Storage projects Installed between 2017 and 2020

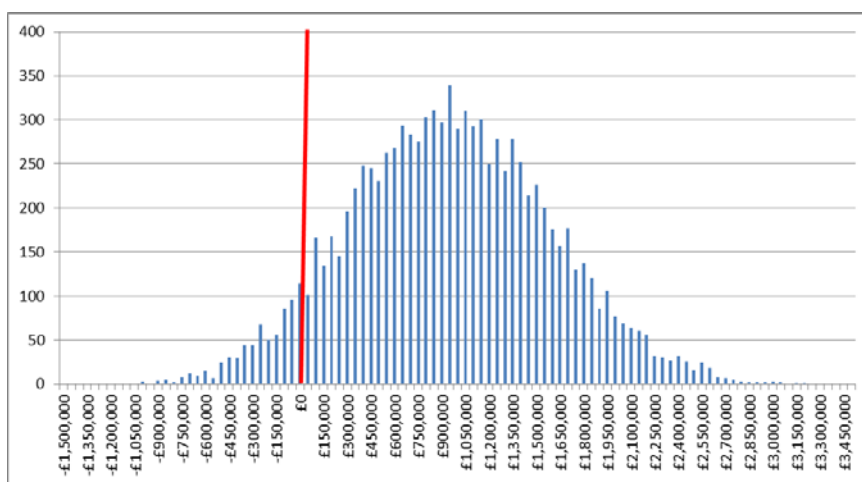

These results prove that, for projects to be installed between 2017 and 2020, the social benefits outweigh the costs. The investment in a grid-scale EES project would likely satisfy the Kaldor-Hicks criterion, even with sub-par market prices and shadow prices or a higher discount rate. The decline in the cost of grid-scale EES is the main driver for the improved NPV of grid-scale EES projects exhibited over time. The net benefits in the future could be even larger with electricity market reforms that would enable grid-scale energy storage projects to simultaneously capture additional revenue streams, such as the enhanced frequency response market and the capacity market. Furthermore, locational benefits are critical contributions to the overall success of a project and optimally siting grid-scale EES projects in locations with high distribution deferral and network

support value can turn projects from a negative NPV to a positive NPV. Sustained investment and production-cost efficiency contributed to a techno-economic performance improvement approximately £2.42 million between 2013 and 2017-2020.

6. Conclusions

The social cost benefit analysis provides a strong framework to assess the public investment in grid-scale EES. This framework accounts for both the market and non-market benefits from the perspective of society and juxtaposes them with the social costs, thereby capturing insights into economic development, equity, and efficiency. Transfer payments between agents within society are removed from the analysis to provide a project appraisal that truly represents the net value to society. Through the Kaldor-Hicks criterion, a positive NPV of the grid-scale EES investment improves the state of society overall.

It is also concluded that a Monte Carlo simulation should be paired with the social cost benefit analysis when incorporating the risk and uncertainty of future benefit and cost streams of grid-scale EES. Rather than providing deterministic values, stochastic modelling incorporates the many real-world variables that affect the net present value of a project. For a stochastic sensitivity analysis, Monte Carlo simulations are helpful because statistical distributions can be applied to the benefit and cost streams.

The benefit streams from the Smarter Network Storage project are only a subset of the universe of possible benefits emanating from grid-scale EES. Although the Smarter Network Storage project was the first battery in Great Britain to successfully provide multiple market services, some services were not able to be paired together or were not truly social benefits. Key benefit streams of grid-scale EES projects, such as Capacity Markets, STOR, and Triad Avoidance, were concluded to be either not social benefits or uneconomical to perform.

Within the social benefit analysis, it is critical to include energy capacity and electrical efficiency degradation. The degradation determines the lifespan of the project, which directly impacts the value of distribution deferment and the terminal value of the asset and indirectly affects the other six benefit streams. Claiming the value of distribution deferment is equivalent to the cost of the conventional distribution upgrade would overstate the true value because the Smarter Network Project is a 10 to 14-year investment; whereas, the conventional distribution upgrade is a 40-year investment. Thus, the value of distribution deferment should be calculated as a fraction of the cost of the conventional distribution upgrade, subject to the timespan of the deferment.

The results of the social cost benefit analysis show that an EES project installed in 2013 likely had a negative NPV, but an identical project installed between 2017 and 2020 likely will have a positive NPV. The social welfare generated from EES continues to increase via capital cost decline, performance and lifespan improvement, optimizing locational benefits, and electricity markets reform to favourable grid-scale EES technologies, such as the provision of potential ancillary services like enhanced frequency response. Costs can be lowered through electricity market reforms to prevent interconnection costs from being applied twice to the battery because the battery is currently classified as a generator and consumer. Benefits can be increased through electricity market reforms that support long-term financial contracts, value the ability of grid-scale EES to provide upward and downward reserves, allow grid-scale EES to provide more services simultaneously. However, benefit streams remain subject to wide ranges of uncertainty. Ultimately,

the analysis shows how society can cost-effectively invest in EES as a grid modernization asset to facilitate the transition to a reliable, affordable, and clean power system in Great Britain.

References

- Anaya, K. and Pollitt, M.G., 2017. Going smarter in the connection of distributed generation. *Energy Policy*, Vol. 105 Pages 608-617. Available at: <http://www.sciencedirect.com/science/article/pii/S0301421517300460>
- ARENA, 2015. Australian Renewable Energy Agency. Energy Storage Study: Funding and Knowledge Sharing Priorities. Prepared by AECOM Australia Pty Ltd. Available at: <https://arena.gov.au/files/2015/07/AECOM-Energy-Storage-Study.pdf>
- BNEF, 2017. Randall, T. Tesla's Battery Revolution Just Reached Critical Mass. *Bloomberg New Energy Finance*. 30 January 2017. Available at: <https://www.bloomberg.com/news/articles/2017-01-30/tesla-s-battery-revolution-just-reached-critical-mass>
- CPUC, 2015. California Public Utilities Commission. Distribution Resources Plan (R.14-08-013). Available at: <http://www.cpuc.ca.gov/General.aspx?id=5071>
- DECC, 2009. Department of Energy and Climate Change. Carbon Valuation in UK Policy Appraisal: A Revised Approach. *Climate Change Economics*. Available at: https://www.gov.uk/government/uploads/system/uploads/attachment_data/file/245334/1_20090715105804_e_carbonvaluationinukpolicyappraisal.pdf
- DOE, 2013. DOE/EPRI 2013 Electricity Storage Handbook. *Sandia National Laboratories and U.S. Department of Energy*. Available at: <https://energy.gov/sites/prod/files/2013/08/f2/ElecStorageHndbk2013.pdf>
- Domah, P. and Pollitt, M.G., 2001. The Restructuring and Privatisation of the Electricity Distribution and Supply Business in England and Wales: A Social Cost Benefit Analysis. *University of Cambridge*. Available at: <http://www.econ.cam.ac.uk/dae/repec/cam/pdf/wp0007.pdf>
- EC-JRC, 2013. Zucker, A., Hinchliffe, T. and Spisto, A. Assessing Storage Value in Electricity Markets. *European Commission JRC Scientific and Policy Reports*. Available at: [http://publications.jrc.ec.europa.eu/repository/bitstream/JRC83688/2013-10-09%20edf%20jrc%20power%20storage%20final%20%20\(online%20version\)%20.pdf](http://publications.jrc.ec.europa.eu/repository/bitstream/JRC83688/2013-10-09%20edf%20jrc%20power%20storage%20final%20%20(online%20version)%20.pdf)
- EMR, 2017. EMR Settlement Service Provider Limited. Capacity Market. Accessed 2017. Available at: <https://www.emrsettlement.co.uk/about-emr/capacity-market/>
- EPRI, 2010. Electric Power Research Institute. Electricity Energy Storage Technology Options: A White Paper Primer on Applications, Costs, and Benefits. Available at: <http://large.stanford.edu/courses/2012/ph240/doshay1/docs/EPRI.pdf>
- ESA, 2015. Hamilton, K. Energy Storage: State of the Industry. *Energy Storage Association*. Available at: <https://www.eia.gov/conference/2015/pdf/presentations/hamilton.pdf>
- Free, R.C. 2010. *21 Century Economics: A Reference Handbook*. Page 276. Available at: https://books.google.co.uk/books?id=nQBzAwAAQBAJ&redir_esc=y
- Galal, A., Jones, L., Tandon, P., and Vogelsang, I., 1994. Welfare Consequences of Selling Public Enterprises: An Empirical Analysis. *Oxford University Press for the World Bank*. Available at: <http://documents.worldbank.org/curated/en/517121468052737074/Welfare-consequences-of-selling-public-enterprises-an-empirical-analysis-a-summary>
- GNZ, 2015. Government of New Zealand Government. Guide to Social Cost Benefit Analysis. *The Treasury*. Available at: <http://www.treasury.govt.nz/publications/guidance/planning/costbenefitanalysis/guide/cba-guide-jul15.pdf>

- Greenwood, D., Wade, N., Heyward, N., Mehta, P., Taylor, P., and Papadopoulos, P., 15-18 June 2015. Scheduling Power and Energy Resources in the Smarter Network Storage Project. 23rd *International Conference on Electricity Distribution*, Paper 0824. Available at: http://cired.net/publications/cired2015/papers/CIRED2015_0824_final.pdf
- Greve, T. and Pollitt, M.G., 2016. A VCG Auction for Electricity Storage. *EPRG Working Paper Series, University of Cambridge*. Available at: <http://www.eprg.group.cam.ac.uk/wp-content/uploads/2016/04/1613-PDF.pdf>
- GTM, 2016. Lacey, S. Stem CTO: Lithium-Ion Battery Prices Fell 70% in the Last 18 Months. *Greentech Media*. 28 June 2016. Available at: <https://www.greentechmedia.com/articles/read/stem-cto-weve-seen-battery-prices-fall-70-in-the-last-18-months>
- LeightonNet, 2017. Leighton Buzzard Battery – largest battery in Europe. Accessed April 2017. Available at: <http://leighton-buzzard.co.uk/battery.htm>
- MassDOER, 2016. Massachusetts Department of Energy Resources and Massachusetts Clean Energy Centre. State of Charge Report. *Massachusetts Energy Storage Initiative*. Available at: <http://www.mass.gov/eea/docs/doer/state-of-charge-report.pdf>
- National Grid, 2017a. Keeping the Electricity System in Balance. Accessed April 2017. Available at: <http://www2.nationalgrid.com/uk/services/balancing-services/>
- National Grid, 2017b. FFR Market Information and Tender Reports. Accessed April 2017. Available at: <http://www2.nationalgrid.com/UK/Services/Balancing-services/Frequency-response/Firm-Frequency-Response/Firm-Frequency-Response-Information/>
- National Grid, 2017c. “Future Requirements for Balancing Services.” Accessed February 2017.
- National Grid, 2016. Final Auction Results: T-4 Capacity Market Auction for 2020/2021. Available at: <https://www.emrdeliverybody.com/Capacity%20Markets%20Document%20Library/Final%20Results%20Report%20-%20T-4%202016.pdf>
- National Grid, 2015. Introduction to Triads. Available at: <http://www2.nationalgrid.com/WorkArea/DownloadAsset.aspx?id=44940>
- Newbery, D. 2016. A Simple Introduction to the Economics of Storage: Shifting Demand and Supply over Time and Space. *EPRG Working Paper Series, University of Cambridge*. Available at: <http://www.eprg.group.cam.ac.uk/wp-content/uploads/2016/10/1626-Text.pdf>
- NREL, 2015. Stark, C., Pless, J., Logan, J., Zhou, E., and Arent, D.J., Renewable Electricity: Insights for the Coming Decade. Prepared by Joint Institute for Strategic Energy Analysis. Available at: <http://www.nrel.gov/docs/fy15osti/63604.pdf>
- NY REV, 2015. New York Department of Public Service. Staff White Paper on Benefit-Cost Analysis in the Reforming Energy Vision Proceeding 14-M-0101. *New York Reforming the Energy Vision*. Available at: [https://www3.dps.ny.gov/W/PSCWeb.nsf/96f0fec0b45a3c6485257688006a701a/c12c0a18f55877e785257e6f005d533e/\\$FILE/Staff_BCA_Whitepaper_Final.pdf](https://www3.dps.ny.gov/W/PSCWeb.nsf/96f0fec0b45a3c6485257688006a701a/c12c0a18f55877e785257e6f005d533e/$FILE/Staff_BCA_Whitepaper_Final.pdf)
- OFGEM, 2017. Office of Gas and Electricity Markets authority. Electricity Security of Supply. Accessed April 2017. Available at: <https://www.ofgem.gov.uk/electricity/wholesale-market/electricity-security-supply>
- OFGEM, 2015. Office of Gas and Electricity Markets authority. Electricity Storage – Comparative Case Studies. Prepared by DNV GL. Available at: https://www.ofgem.gov.uk/system/files/docs/2016/07/electricity_storage_comparative_case_studies_a_report_by_dnv-gl.pdf

- Perez, A., Moreno, R., Moreira, R., Orchard, M., and Strbac, G., October 2016. Effect of Battery Degradation on Multi-Service Portfolios of Energy Storage. *IEEE Transactions on Sustainable Energy*, Volume 7 Number 4. Available at: <http://ieeexplore.ieee.org/stamp/stamp.jsp?arnumber=7508879>
- PNNL, 2015. De Martini, P., Taft, J.D., and Kristov, L., July 2015. A Reference Model for Distributed Grid Control in the 21st Century. *Pacific Northwest National Laboratory*. Available at: http://energyenvironment.pnnl.gov/pdf/Distribution_Control_Ref_Model_v1.1_final.pdf
- RMI, 2015. Rocky Mountain Institute. The Economics of Battery Energy Storage. Available at: <http://www.rmi.org/Content/Files/RMI-TheEconomicsOfBatteryEnergyStorage-FullReport-FINAL.pdf>
- Shcherbakova, A., Kleit, A., and Cho, J., 2014. The value of energy storage in South Korea's electricity market: A Hotelling approach. *Applied Energy*, Vol. 125 Pages 93-102. Available at: <http://www.sciencedirect.com/science/article/pii/S0306261914002773>
- Sandia, 2008. Eyer, J.M., and Schoenung, S.M. Benefit/Cost Framework for Evaluating Modular Energy Storage. *Sandia National Laboratories*. Available at: https://www.researchgate.net/publication/255249024_Benefitcost_framework_for_evaluating_modular_energy_storage_a_study_for_the_DOE_energy_storage_systems_program
- SNS, 2016a. Smarter Network Storage. Final evaluation of the Smarter Network Storage solution (SDRC 9.8). *UK Power Networks*. Available at: [http://innovation.ukpowernetworks.co.uk/innovation/en/Projects/tier-2-projects/Smarter-Network-Storage-\(SNS\)/Project-Documents/SNS+UKPN+Report+9.8+05Jan.pdf](http://innovation.ukpowernetworks.co.uk/innovation/en/Projects/tier-2-projects/Smarter-Network-Storage-(SNS)/Project-Documents/SNS+UKPN+Report+9.8+05Jan.pdf)
- SNS, 2016b. Smarter Network Storage. The Business Case for Storage. *UK Power Networks*. Available at: [http://innovation.ukpowernetworks.co.uk/innovation/en/Projects/tier-2-projects/Smarter-Network-Storage-\(SNS\)/Project-Documents/The+business+case+of+Storage.pdf](http://innovation.ukpowernetworks.co.uk/innovation/en/Projects/tier-2-projects/Smarter-Network-Storage-(SNS)/Project-Documents/The+business+case+of+Storage.pdf)
- SNS, 2016c. Smarter Network Storage. UK Power Networks SNS final learning event presentation slides. *UK Power Networks*. Available at: [http://innovation.ukpowernetworks.co.uk/innovation/en/Projects/tier-2-projects/Smarter-Network-Storage-\(SNS\)/Project-Documents/UKPN+SNS+2+Dec+final+learning+event+presentation+slides.pdf](http://innovation.ukpowernetworks.co.uk/innovation/en/Projects/tier-2-projects/Smarter-Network-Storage-(SNS)/Project-Documents/UKPN+SNS+2+Dec+final+learning+event+presentation+slides.pdf)
- SNS, 2016d. Smarter Network Storage. Successful Demonstrations of Storage Value Streams (SDRC 9.7). *UK Power Networks*. Available at: [http://innovation.ukpowernetworks.co.uk/innovation/en/Projects/tier-2-projects/Smarter-Network-Storage-\(SNS\)/Project-Documents/SDRC+9.7+Successful+Demonstrations+of+Storage+Value+Streams+LoRes+v1.pdf](http://innovation.ukpowernetworks.co.uk/innovation/en/Projects/tier-2-projects/Smarter-Network-Storage-(SNS)/Project-Documents/SDRC+9.7+Successful+Demonstrations+of+Storage+Value+Streams+LoRes+v1.pdf)
- SNS, 2014. Smarter Network Storage. Electricity Storage in GB: Regulatory and Legal Framework (SNS 4.13). *UK Power Networks*. Available at: [http://innovation.ukpowernetworks.co.uk/innovation/en/Projects/tier-2-projects/Smarter-Network-Storage-\(SNS\)/Project-Documents/Report+9.5+19Oct_v2.1_\(Final+Photos\).pdf](http://innovation.ukpowernetworks.co.uk/innovation/en/Projects/tier-2-projects/Smarter-Network-Storage-(SNS)/Project-Documents/Report+9.5+19Oct_v2.1_(Final+Photos).pdf)
- SNS, 2013a. Smarter Network Storage. Investment Model Template (SNS 4.11). *UK Power Networks*. Available at: [http://innovation.ukpowernetworks.co.uk/innovation/en/Projects/tier-2-projects/Smarter-Network-Storage-\(SNS\)/Project-Documents/SNS+UKPN+Report+9.8+05Jan.pdf](http://innovation.ukpowernetworks.co.uk/innovation/en/Projects/tier-2-projects/Smarter-Network-Storage-(SNS)/Project-Documents/SNS+UKPN+Report+9.8+05Jan.pdf)

- SNS, 2013b. Smarter Network Storage. Design and planning considerations for large-scale distribution-connected energy storage (SNS 1.2). *UK Power Networks*. Available at: [http://innovation.ukpowernetworks.co.uk/innovation/en/Projects/tier-2-projects/Smarter-Network-Storage-\(SNS\)/](http://innovation.ukpowernetworks.co.uk/innovation/en/Projects/tier-2-projects/Smarter-Network-Storage-(SNS)/)
- SNS, 2013c. Smarter Network Storage. Logical Architecture Design Document (SNS 2.15). *UK Power Networks*. Available at: [http://innovation.ukpowernetworks.co.uk/innovation/en/Projects/tier-2-projects/Smarter-Network-Storage-\(SNS\)/Project-Documents/SNS2.15-Logical-Architecture-Design-Dec+2013.pdf](http://innovation.ukpowernetworks.co.uk/innovation/en/Projects/tier-2-projects/Smarter-Network-Storage-(SNS)/Project-Documents/SNS2.15-Logical-Architecture-Design-Dec+2013.pdf)
- SNS, 2012. Smarter Network Storage. Low Carbon Networks Fund Full Submission Pro-forma. *UK Power Networks*. Available at: <https://www.ofgem.gov.uk/ofgem-publications/46102/sns-original-submission-appendices-redacted.pdf>
- UKPN, 2017. UK Power Networks. Flexible Distributed Generation (FDG) connections. Accessed March 2017. Available at: <https://www.ukpowernetworks.co.uk/internet/en/our-services/list-of-services/electricity-generation/flexible-distributed-generation/>
- UKPN, 2014. UK Power Networks. Demonstrating the benefits of short-term discharge energy storage on an 11kV distribution network. Version 1.1. Page 9. Available at: <https://www.ofgem.gov.uk/ofgem-publications/89119/hemsbylcnftier1closedownreport6.06.14.pdf>
- Walawalkar, Rahul, Jay Apt, and Rick Mancini. November 2006. Economics of electric energy storage for energy arbitrage and regulation in New York. *Energy Policy* Volume 35, pages 2258 – 2568. Available at: <http://www.cmu.edu/gdi/docs/economics-of-electric.pdf>
- Weightman, Alfred and Kiran Arora. 2016. Energy Storage: Behind the Meter Part 2 – Ancillary Services. *Berwin Leighton Paisner LLC*. Available at: <http://www.blplaw.com/expert-legal-insights/articles/energy-storage-behind-the-meter-part-2-ancillary-services>
- Woodbank Communications. 2005. State of Charge (SOC) Determination. Available at: <http://www.mpoweruk.com/soc.htm>

Appendix A. Assumptions Table

Variable	Determined Values	Reference	Confidence Interval
Financial Assumptions			
Discount Rate	5.09%	SNS 2013a	3.8% - 7.2%
Electricity Wholesale Price	£40/MWh	SNS 2013a	+/- 15%
Depreciation	18%	SNS 2013a	+/- 5%
Performance Assumptions			
Energy Capacity	10 MWh	SNS 2013a	
Power Capacity	6 MW	SNS 2013a	
Efficiency	87%	SNS 2012	
Lifespan	12 years (one cycle per day)	SNS 2013a Perez et al., 2016	+/- 2 years
Technical Variables			
Wind Capacity Factor	30%	Anaya and Pollitt, 2017	
Solar Capacity Factor	11.16%	Anaya and Pollitt, 2017	

Appendix B. Operating Costs Table

Variable	Assumed Values	Reference	Confidence Interval
Operating Costs			
Inspection & Maintenance	£10,000 p.a.	SNS 2013a	
Spare Parts	£5,000 p.a.	SNS 2013a	
Facilities Cost	£40,000 p.a.	SNS 2013a	
Insurance	£5,000 p.a.	SNS 2013a	
Management/Administration	£15,000 p.a.	SNS 2013a	
Self-Discharge Losses	£18 p.a.	SNS 2013a	
Control Systems and Risk Management	£10,000 p.a.	SNS 2013a	
Electricity Purchasing	Charging at £40/MWh	SNS 2013a	Market Price varies +/- 15%

Appendix C. Benefits Calculations Table

Variable	Assumed Values	Reference	Confidence Interval
Benefits Calculations			
Frequency Response	Holding Payment £8.00/MW/hr	National Grid 2017b	+/- 25%
	Utilisation Payment £24.00/MW/hr	National Grid 2017b	+/- 25%
Arbitrage	Buy at £30/MWh	SNS 2013a	+/- 15%
	Sell at £50/MWh	SNS 2013a	+/- 15%
Distribution Deferral	Value of the counterfactual is £6.2 million	SNS 2013a	Deferral lasted 10-14 years
Network Support	£48/kW-yr	SNS 2016a	The expected value is -15%. The lower bound is -30%.
Security of Supply	Buy at £30/MWh	SNS 2013a	+/- 15%
	Sell at £50/MWh	SNS 2013a	+/- 15%
Increased Distributed Generation	Wholesale Market Price at £40/MWh	SNS 2013a	DG capacity 4-8 MW Growth rate 5-15% p.a. Market Price varies +/- 15%
Carbon Abatement	1.7 kilo tonnes of CO ₂ abated p.a.	SNS 2013c DECC 2009	Price of carbon determined by DECC (2009)
Terminal Value of Asset	Depreciation is 18%	SNS 2013a	+/- 5%
	Lifespan is 12 years	SNS 2013a Perez et al., 2016	+/- 2 years